

**Tschenet**  
Licht GmbH

**Lichtstärke aus Erfahrung**





Hinter dem Namen TSCHENET LICHT stehen mehr als 30 Jahre Erfahrung am Beleuchtungssektor.

Von der Lichtplanung und Konzeption über Handel und Montage bekommen Sie von uns ALLES AUS EINER HAND. Durch ständige Weiterentwicklung sind wir insbesondere am LED Sektor am neuesten Stand der Technik. Von dieser Kompetenz profitieren unsere Kunden.

Bei uns bekommen Sie auch Einzelanfertigungen und Sonderbauten aus unserer Manufactur, Leuchten-Restaurierungen und Umrüstungen werden ebenfalls gerne übernommen.

Ganz neu jetzt bei TSCHENET LICHT:

Raumakustik-Planung in Verbindung mit Beleuchtungssystemen.

Kontaktieren Sie uns und überzeugen Sie sich selber von den vielfältigen Möglichkeiten, Licht zu gestalten.



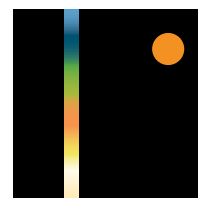

## INHALTSVERZEICHNIS

Profile .....	Seite 5 – 18
LED Bänder .....	Seite 20 – 26
LED Bänder Zubehör .....	Seite 27 – 29
Steuerungen und Fernbedienungen .....	Seite 31 – 33
Trafos .....	Seite 34 – 35
Konfektionierungen .....	Seite 36 - 36





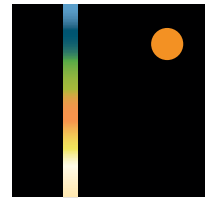

## LED Aluminiumprofile

## Profil A



Bezeichnung	Maße	Bild	Artikelnummer	Artikelbezeichnung	Preis per Stück in Euro
<b>LED Profil A</b> Oberflächenprofil  Zur Beleuchtung von Wohnräumen und Wohnbereichen	 		16L10001420	<b>Profil A silber eloxiert 2020mm</b>	11,20
			16L11201110	Abdeckung BASIC Milchweiss 2020 mm	4,80
			16L11205110	Abdeckung HOCH-Milchweiss 2020 mm	8,30
			16L11206010	Abdeckung BASIC 2020 mm Lens 15	16,40
			16L12001400	Endkappe BASIC grau mit Loch	0,50
			16L12001401	Endkappe BASIC grau ohne Loch	0,50
			16L12002400	Endkappe HOCH grau mit Loch	0,50
			16L12002401	Endkappe Hoch grau ohne Loch	0,50
			16L13002300	Montageklammer Mini A Transparent	0,90
			16L13001300	Montageklammer A Transparent	0,90
			16L13003300	Montageklammer Hoch A Transparent	0,90
			16L13011002	Montageklammer A Metall	1,12
			39T780003	Scotch Klebeband 25 Meter	35,00

Abdeckung BASIC



Abdeckung HOCH



Abdeckung BASIC Lens 15



Endkappe BASIC mit Loch

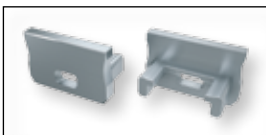

Endkappe BASIC ohne Loch

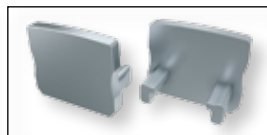

Endkappe HOCH mit Loch

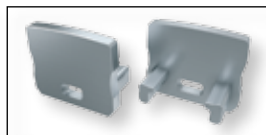

Endkappe HOCH ohne Loch

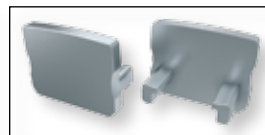

Montageklammer Mini A

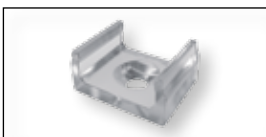

Montageklammer A

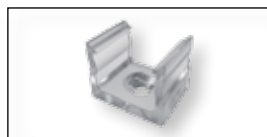

Montageklammer Hoch A

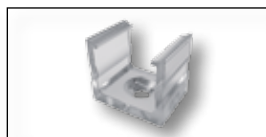

Montageklammer A Metall

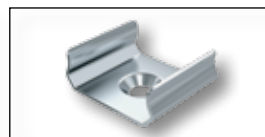

Scotch doppelstg. Klebeband

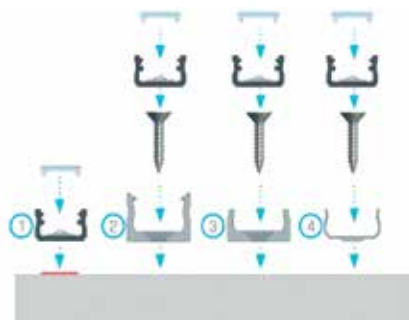

Montageanleitung für das Profil A mit Abdeckung BASIC, (1) doppelseitiges Klebeband, (2) Montageklammer A, (3) mit MINI-Montageklammer A, (4) mit Metallklammer A



Fertiges Resultat nach der Montage des Profils A mit Abdeckung BASIC, (1) doppelseitigem Klebeband, (2) Montageklammer A, (3) MINI-Montageklammer A, (4) Metallmontageklammer A



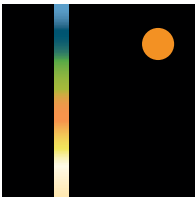

## LED Profil A Oberflächenprofil - Montageanleitung

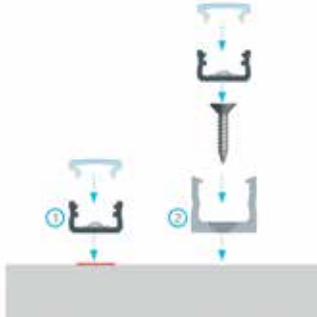

Montageanleitung für das Profil A mit Abdeckung HIGH, (1) doppelseitiges Klebeband, (2) mit Montageklammer A HIGH



Fertiges Resultat nach der Montage des Profils A mit Abdeckung HIGH, (1) doppelseitigem Klebeband, (2) mit Montageklammer A HIGH



Explosionszeichnung zum Beleuchtungssystem bestehend aus folgenden Elementen: Profil A und (1) Abdeckung BASIC, (2) LED-Streifen, (3) Endkappe mit Öffnung, (3a) Endkappe ohne Öffnung, (4) Montageschraube, (5) MINI-Montageklammer A





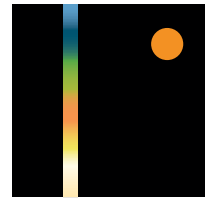

## LED Aluminiumprofile

## Profil C

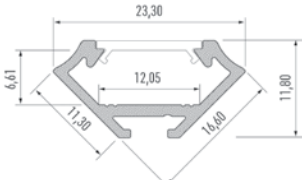

Bezeichnung	Maße	Bild	Artikelnummer	Artikelbezeichnung	Preis per Stück in Euro	
<b>LED Profil C</b> Eckprofil 45° Zur Beleuchtung von Küchen, Verkaufsf- lächen, Schränken, Platten, Treppen- stufen	 		16L10003420	<b>Profil C Silber eloxiert 2020mm</b>	14,40	
			16L11201110	Abdeckung BASIC Milchweiss 2020 mm	4,80	
			16L11206010	Abdeckung BASIC 2020 mm Lens 15	16,40	
			16L12004400	Endkappe grau mit Loch	0,50	
			16L12004401	Endkappe grau ohne Loch	0,50	
			16L13004300	Montageklammer CH Transparent	0,90	
			16L13012002	Montageklammer CH Metall	1,12	
			39T780003	Scotch Klebeband 25 Meter	35,00	

Abdeckung BASIC

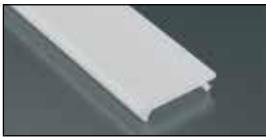

Abdeckung BASIC Lens 15



Endkappe mit Loch

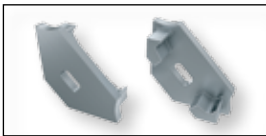

Endkappe ohne Loch

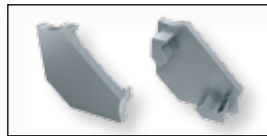

Montageklammer CH



Montageklammer CH Metall

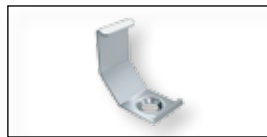

Scotch doppelstg. Klebeband



Montageanleitung für das Eckprofil C mit Abdeckung BASIC und doppelseitigem Klebeband



Fertiges Resultat nach der Montage des Eckprofils C mit Abdeckung BASIC und doppelseitigem Klebeband



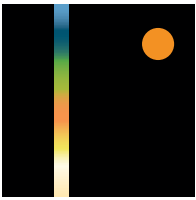

## LED Profil C - Eckprofil Montageanleitung



Montageanleitung für das Eckprofil C mit Abdeckung BASIC mit (1) Kunststoffmontageklammer CH, (2) Metallmontageklammer CH



Fertiges Resultat nach der Montage des Eckprofils C mit (1) Kunststoffmontageklammer CH, (2) Metallmontageklammer CH

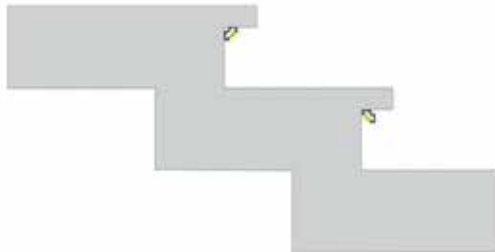

Montagearten für das Profil C auf Treppenstufen

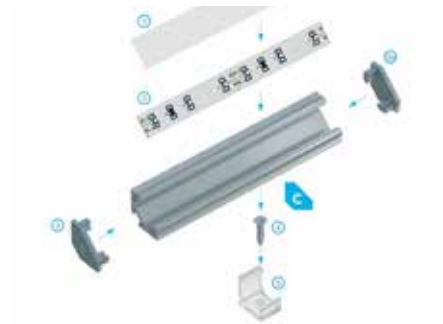

Explosionszeichnung zum Beleuchtungssystem bestehend aus folgenden Elementen: Eckprofil C und (1) Abdeckung BASIC, (2) LED-Streifen, (3) Endkappe mit Öffnung, (3a) Endkappe ohne Öffnung, (4) Montageschraube, (5) Montageklammer CH



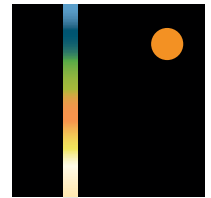

## LED Aluminiumprofile

## Profil D



Bezeichnung	Maße	Bild	Artikelnummer	Artikelbezeichnung	Preis per Stück in Euro
<b>LED Profil D</b> Oberflächenprofil  Zur Beleuchtung von Küchen, Verkaufsflächen, Schränken, Platten, Treppen	 	16L10004420	<b>Profil D Silber eloxiert 2020mm</b>	9,50	
		16L11201110	Abdeckung BASIC Milchweiss 2020 mm	4,80	
		16L11205110	Abdeckung HOCH-Milchweiss 2020 mm	8,30	
		16L11206010	Abdeckung BASIC 2020 mm Lens 15	16,40	
		16L12005400	Endkappe BASIC grau mit Loch	0,50	
		16L12005401	Endkappe BASIC grau ohne Loch	0,50	
		16L12006400	Endkappe HOCH grau mit Loch	0,50	
		16L12006401	Endkappe Hoch grau ohne Loch	0,50	
		16L13005300	Montageklammer Mini D Transparent	0,90	
		16L13006300	Montageklammer Hoch D Transparent	0,90	
		16L13014002	Montageklammer D Metall	1,12	
		39T780003	Scotch Klebeband 25 Meter	35,00	

Abdeckung BASIC



Abdeckung HOCH

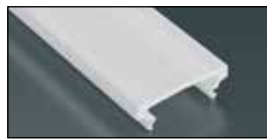

Abdeckung BASIC Lens 15



Endkappe BASIC mit Loch

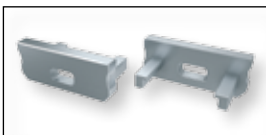

Endkappe BASIC ohne Loch

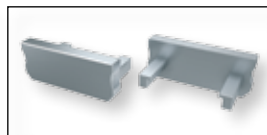

Endkappe HOCH mit Loch

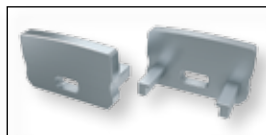

Endkappe HOCH ohne Loch

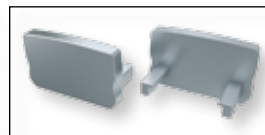

Montageklammer Mini D

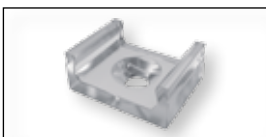

Montageklammer Hoch D

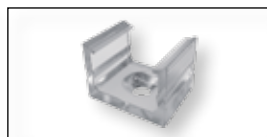

Montageklammer D Metall

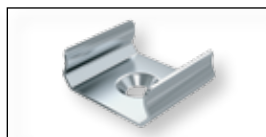

Scotch doppelstg. Klebeband

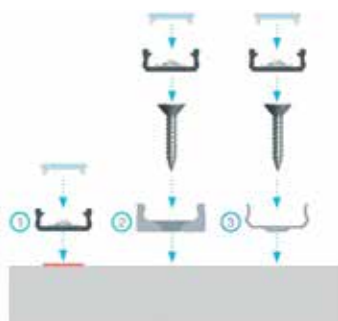

Montageanleitung für das Profil D mit Abdeckung BASIC mit (1) doppelseitigem Klebeband, (2) MINI-Montageklammer D, (3) Metallmontageklammer D

Fertiges Resultat nach der Montage des Profils D mit Abdeckung BASIC mit (1) doppelseitigem Klebeband, (2) MINI-Montageklammer D, (3) Metallmontageklammer D



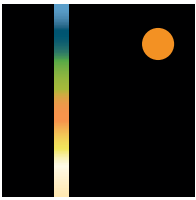

## LED Profil D - Oberflächenprofil Montageanleitung

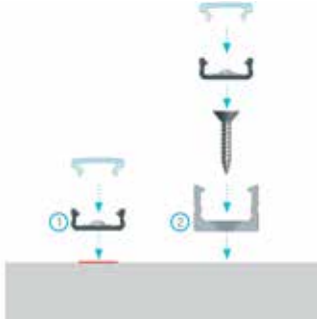

Montageanleitung für das Profil D mit Abdeckung HIGH mit (1) doppelseitigem Klebeband, (2) Montageklammer D HIGH



Fertiges Resultat nach der Montage des Profils D mit Abdeckung HIGH mit (1) doppelseitigem Klebeband, (2) Montageklammer D HIGH



Explosionszeichnung zum Beleuchtungssystem bestehend aus folgenden Elementen: Profil C und (1) Abdeckung BASIC, (2) LED-Streifen, (3) Endkappe mit Öffnung, (3a) Endkappe ohne Öffnung, (4) Montageschraube, (5) MINI-Montageklammer D



Explosionszeichnung zum Beleuchtungssystem bestehend aus folgenden Elementen: Profil C und (1) Abdeckung HIGH, (2) LED-Streifen, (3) Endkappe mit Öffnung, (3a) Endkappe ohne Öffnung, (4) Montageschraube, (5) Montageklammer D HIGH



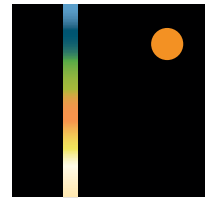

## LED Aluminiumprofile

## Profil X

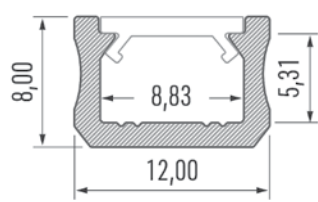

Bezeichnung	Maße	Bild	Artikelnummer	Artikelbezeichnung	Preis per Stück in Euro
<b>LED Profil X</b> Oberflächenprofil  Zur Beleuchtung von Küchen, Verkaufsflächen, Platten, Handläufen	  		16L10008420	<b>Profil X Silber eloxiert 2020mm</b>	8,60
			16L11202110	Abdeckung SLIM Milchweiss 2020 mm	3,20
			16L11206010	Abdeckung SLIM 2020 mm Lens 15	16,40
			16L12008400	Endkappe grau mit Loch	0,50
			16L12008401	Endkappe grau ohne Loch	0,50
			16L13007300	Montageklammer Mini X Transparent	0,90
			16L13016002	Montageklammer X Metall	1,12
			39T780003	Scotch Klebeband 25 Meter	35,00

Abdeckung SLIM



Abdeckung SLIM Lens 15



Endkappe mit Loch

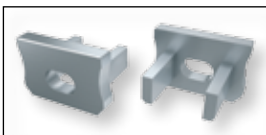

Endkappe ohne Loch

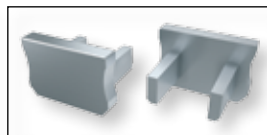

Montageklammer Mini X

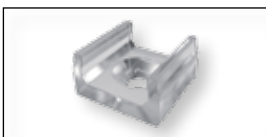

Montageklammer X Metall

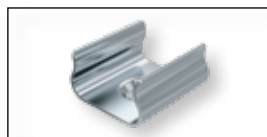

Scotch doppelstg. Klebeband

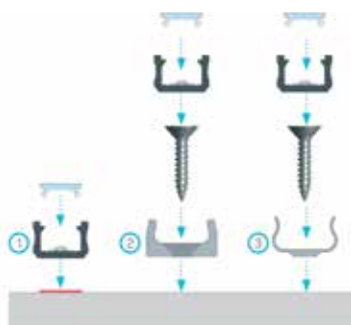

Montageanleitung für das Profil X mit Abdeckung SLIM mit (1) doppelseitigem Klebeband, (2) Montageklammer X, (3) Metallmontageklammer X

Fertiges Resultat nach der Montage des Profils X mit Abdeckung SLIM mit (1) doppelseitigem Klebeband, (2) Montageklammer X, (3) Metallmontageklammer X



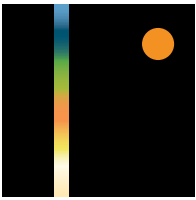

## LED Profil X - Oberflächenprofil Montageanleitung



Dekoratives Resultat nach der Montage des Profils X hinter einer Spiegelkante

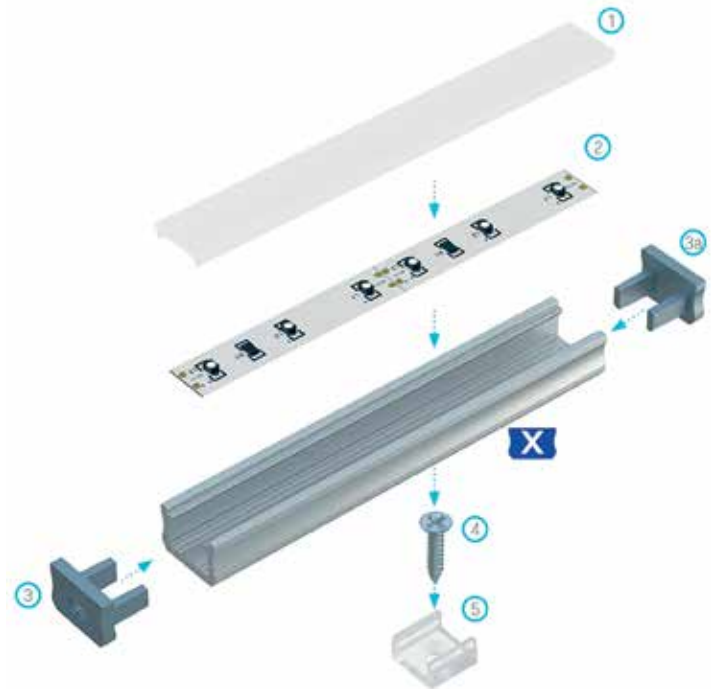

Explosionszeichnung zum Beleuchtungssystem bestehend aus folgenden Elementen: Profil X und (1) Abdeckung SLIM, (2) LED-Streifen, (3) Endkappe mit Öffnung, (3a) Endkappe ohne Öffnung, (4) Montageschraube, (5) Montageklammer X

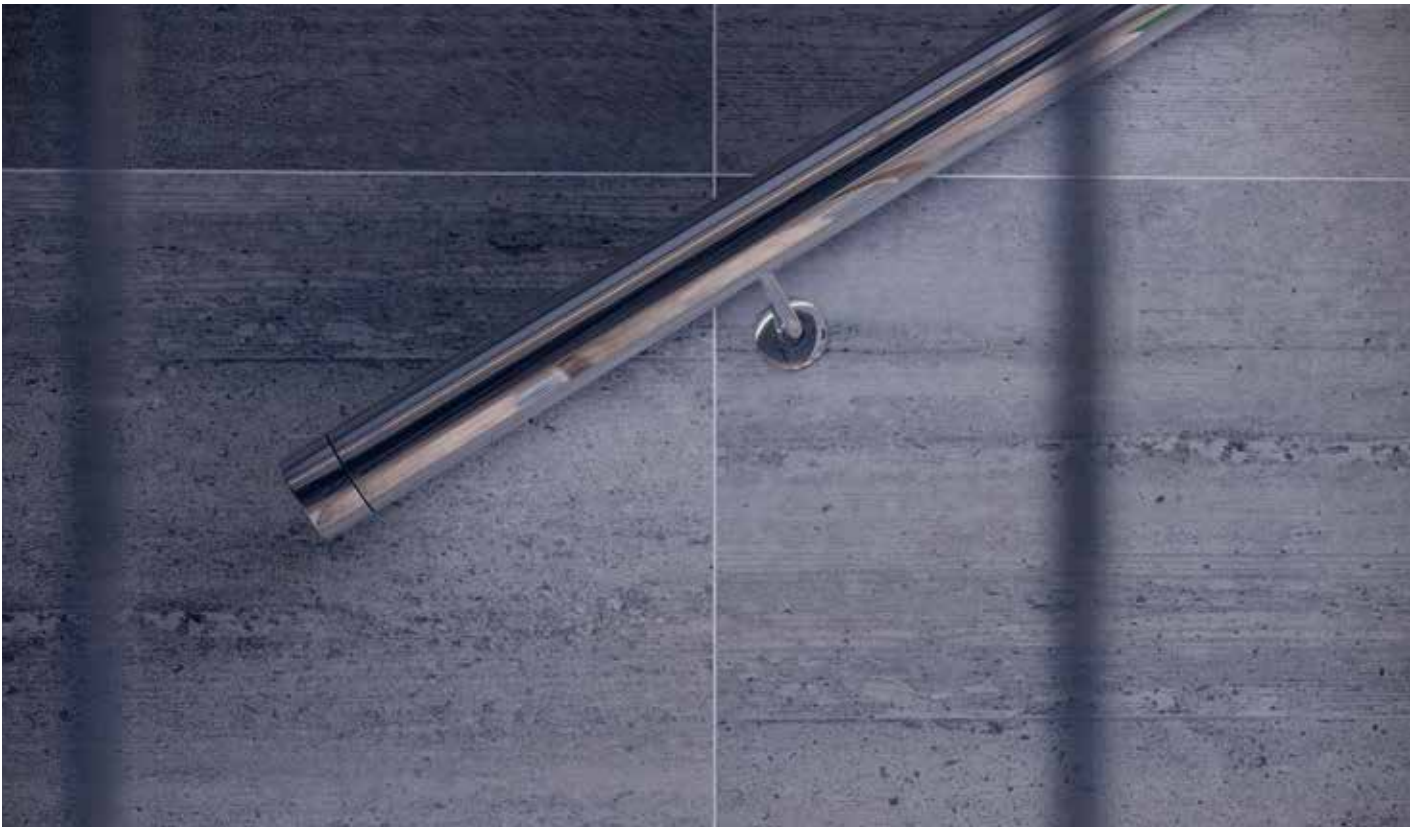

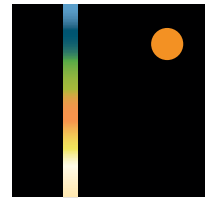

## LED Aluminiumprofile

## Profil Y

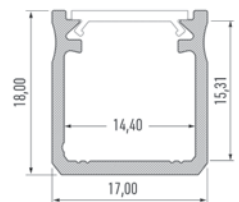

Bezeichnung	Maße	Bild	Artikelnummer	Artikelbezeichnung	Preis per Stück in Euro	
<b>LED Profil Y</b> Oberflächenprofil  Zur Beleuchtung von Wohn- und Büroräumen, Säulen, Platten	  		16L10009420	<b>Profil Y Silber eloxiert 2020mm</b>	16,80	
			16L11201110	Abdeckung BASIC Milchweiss 2020 mm	4,80	
			16L11206010	Abdeckung BASIC 2020 mm Lens 15	16,40	
			16L12009400	Endkappe grau mit Loch	0,50	
			16L12009401	Endkappe grau ohne Loch	0,50	
			16L13008300	Montageklammer Y Transparent	0,90	
			16L10060410	Zusatzprofil M1	12,60	
			39T780003	Scotch Klebeband 25 Meter	35,00	

Abdeckung BASIC



Abdeckung BASIC Lens 15



Zusatzprofil M1



Endkappe mit Loch

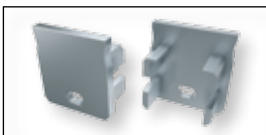

Endkappe ohne Loch

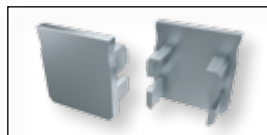

Montageklammer Y



Montageklammer Y Metall

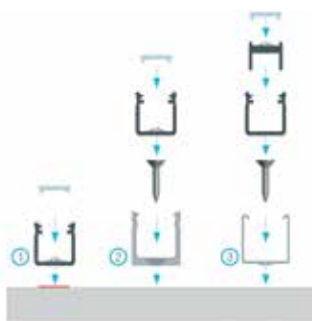

Montageanleitung für das Profil Y mit Abdeckung BASIC mit (1) doppelseitigem Klebeband, (2) Montageklammer Y, (3) Zusatzprofil Y M1

Fertiges Resultat nach der Montage des Profils Y mit Abdeckung BASIC mit (1) doppelseitigem Klebeband, (2) Montageklammer Y, (3) Zusatzprofil Y M1



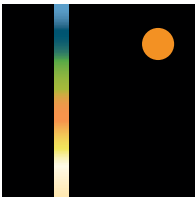

## LED Profil Y - Oberflächenprofil Montageanleitung

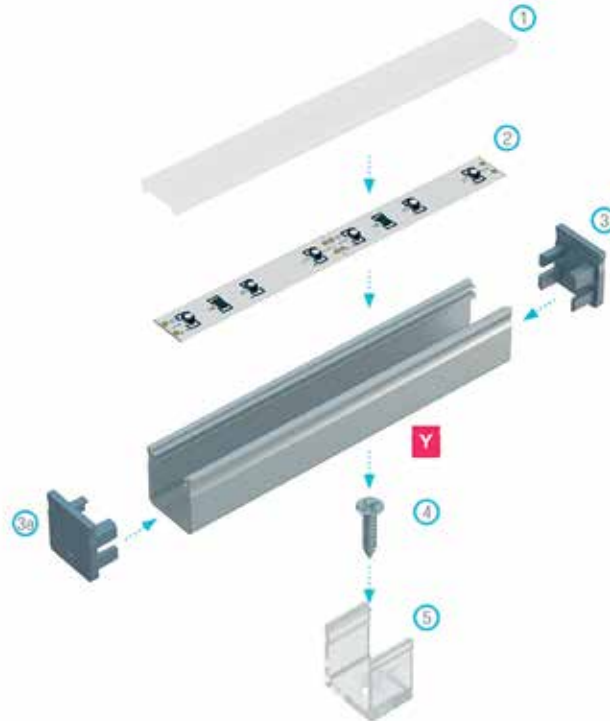

Explosionszeichnung zum Beleuchtungssystem bestehend aus folgenden Elementen: Profil Y und (1) Abdeckung BASIC, (2) LED-Streifen, (3) Endkappe ohne Öffnung, (3a) Endkappe mit Öffnung, (4) Montageschraube, (5) Montageklammer Y





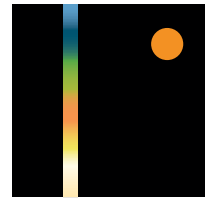

## LED Aluminiumprofile

## Profil Cosmo

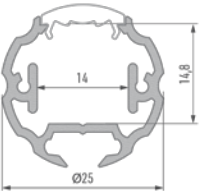

Bezeichnung	Maße	Bild	Artikelnummer	Artikelbezeichnung	Preis per Stück in Euro
<b>LED Profil Cosmo Rundprofil</b>  Zur Schrankbeleuchtung, als Schrankstange, Dekor und Punktbeleuchtung	  		16L10017420	<b>Profil Cosmo Silber eloxiert 2020mm</b>	29,20
			16L10016410	Zusatzprofil M1 Silber eloxiert 2020 mm	€ 10,50
			16L11201110	Abdeckung BASIC Milchweiss 2020 mm	€ 4,80
			16L11206010	Abdeckung BASIC 2020 mm Lens 15	€ 16,40
			16L11208010	Abdeckung BASIC 2020 mm Lens 30	€ 16,40
			16L12092401	Endkappe Cosmo grau	€ 0,50
			16L13013002	Montageklammer Metall	€ 1,15

Abdeckung BASIC

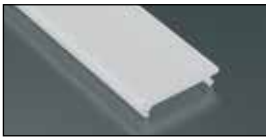

Abdeckung BASIC Lens 15



Abdeckung BASIC Lens 30



Zusatzprofil M1

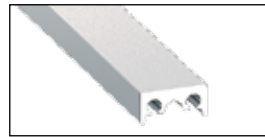

Endkappe Cosmo

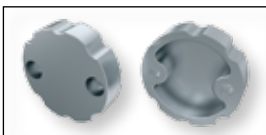

Montageklammer Metall

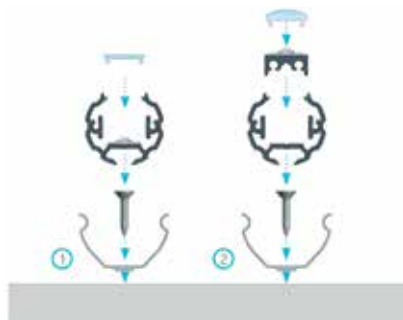

Montageanleitung für das Rundprofil COSMO mit (1) Abdeckung BASIC (2) Abdeckung BASIC LENS 30 mit Zusatzprofil COSMO M1 und Metallmontageklammer COSMO Fertiges Resultat nach der Montage des Rundprofils COSMO mit (1) Abdeckung BASIC (2) Abdeckung BASIC LENS 30 mit Zusatzprofil COSMO M1 und Metallmontageklammer COSMO



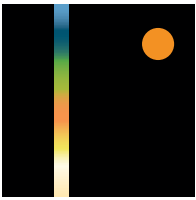

## LED Profil Cosmo - Rundprofil Montageanleitung

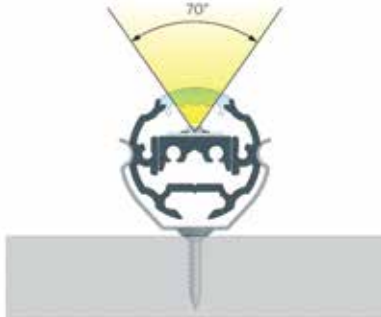

Anwendungsbeispiel für das Zusatzprofil COSMO M1 zur Änderung des Leuchtwinkels – obere Lage des LED Streifens

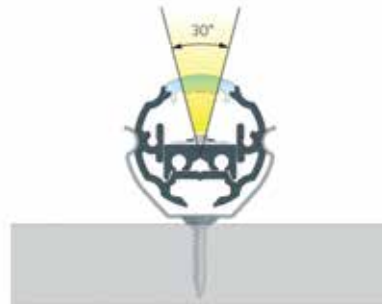

Anwendungsbeispiel für das Zusatzprofil COSMO M1 zur Änderung des Leuchtwinkels – untere Lage des LED Streifens

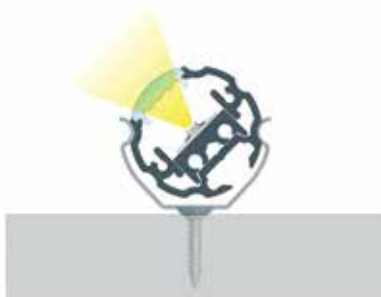

Anwendungsbeispiel für die Änderung der Lage des Profils COSMO um +45° Winkel mit Metallmontageklammer COSMO



Anwendungsbeispiel für die Änderung der Lage des Profils COSMO um -45° Winkel mit Metallmontageklammer COSMO



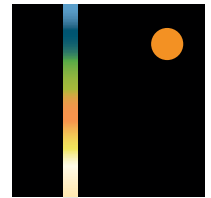

## LED Aluminiumprofile

## Profil Mico



Bezeichnung	Maße	Bild	Artikelnummer	Artikelbezeichnung	Preis per Stück in Euro
<b>LED Profil Mico</b> Rundprofil  Zur Punktbeleuchtung von Bildern, Schaufenstern	 		16L10030420	<b>LED Profil Mico Silber eloxiert 2020mm</b>	13,90
			16L11202110	Abdeckung SLIM Milchweiss 2020 mm	3,20
			16L11206010	Abdeckung SLIM 2020 mm Lens 15	16,40
			16L12098400	Endkappe grau mit Loch	0,50
			16L12098401	Endkappe grau ohne Loch	0,50
			16L13015002	Montageklammer Mico Metall	1,15

Abdeckung SLIM



Abdeckung SLIM Lens 15



Endkappe mit Loch

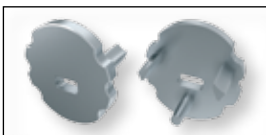

Endkappe ohne Loch

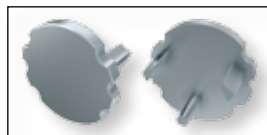

Montageklammer Mico Metall



Montageanleitung für das Rundprofil MICO mit Abdeckung SLIM LENS 15 und Metallmontageklammer MICO



Fertiges Resultat nach der Montage des Rundprofils MICO mit Abdeckung SLIM LENS 15 und Metallmontageklammer MICO



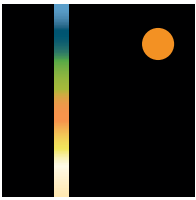

## LED Profil MICO - Rundprofil Montageanleitung

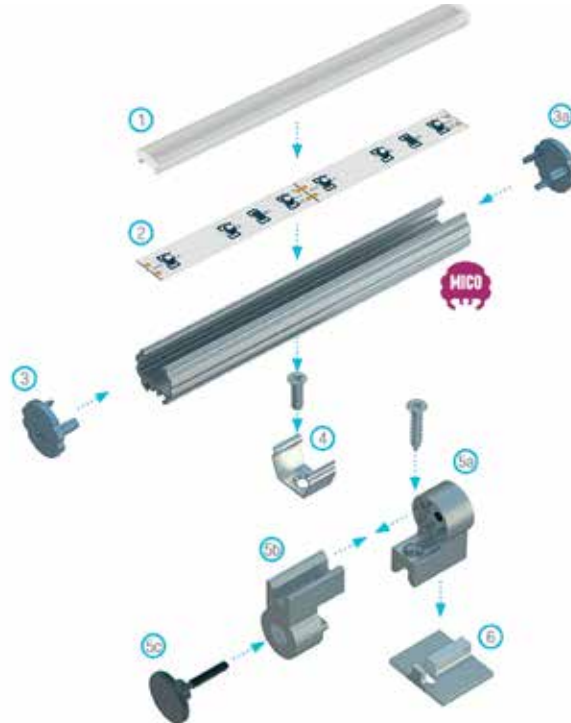

Explosionszeichnung zum Beleuchtungssystem bestehend aus folgenden Elementen: Rundprofil MICO und (1) Abdeckung SLIM LENS 15, (2) LED-Streifen, (3) Endkappe mit Öffnung, (3a) Endkappe ohne Öffnung, (4) Montageklammer MICO





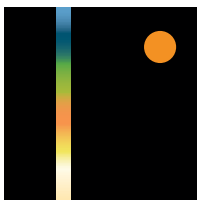



## LED Band 9,6W/m 48W/5m Rolle Single Color

LED Band 9,6W/m 24V DC		48W/Rolle	Warmweiß 2700K	IP20	Preis 5m Rolle
	<b>Artikelnummer</b>	<b>35L482720</b>	Chip Typ	SMD S3528	Euro 44,60
	Spannung	24V DC	Lumen	840 lm per Meter	
	Lichtfarbe	2700k **	Breite/Länge	8mm/5000mm	
	Schutzart	IP20	Anzahl LED	120 LED per Meter	
	Trennbar	jedes 6 Chip 50mm	CRI80		

LED Band 9,6W/m 24V DC		48W/Rolle	Warmweiß 2700K	IP65	Preis 5m Rolle
	<b>Artikelnummer</b>	<b>35L482765</b>	Chip Typ	SMD S3528	Euro 59,80
	Spannung	24V DC	Lumen	840 lm per Meter	
	Lichtfarbe	2700k **	Breite/Länge	8mm/5000mm	
	Schutzart	IP65	Anzahl LED	120 LED per Meter	
	Trennbar	jedes 6 Chip 50mm	CRI80		

LED Band 9,6W/m 24V DC		48W/Rolle	Neutralweiß 4000K	IP20	Preis 5m Rolle
	<b>Artikelnummer</b>	<b>35L484020</b>	Chip Typ	SMD S3528	Euro 44,60
	Spannung	24V DC	Lumen	840 lm per Meter	
	Lichtfarbe	4000k **	Breite/Länge	8mm/5000mm	
	Schutzart	IP20	Anzahl LED	120 LED per Meter	
	Trennbar	jedes 6 Chip 50mm	CRI80		

LED Band 9,6W/m 24V DC		48W/Rolle	Neutralweiß 4000K	IP65	Preis 5m Rolle
	<b>Artikelnummer</b>	<b>35L484065</b>	Chip Typ	SMD S3528	Euro 59,80
	Spannung	24V DC	Lumen	840 lm per Meter	
	Lichtfarbe	4000k **	Breite/Länge	8mm/5000mm	
	Schutzart	IP65	Anzahl LED	120 LED per Meter	
	Trennbar	jedes 6 Chip 50mm	CRI80		

\*\* Achtung ! Die exakte Lichtfarbe kann nur bei Bändern mit gleichem Produktionsdatum garantiert werden (ersichtlich auf der Originalverpackung).

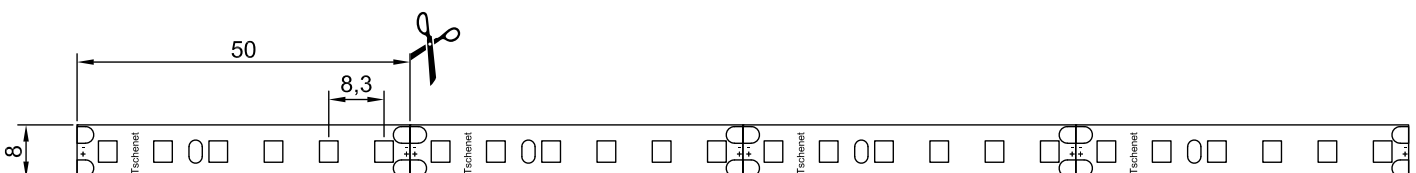



9,6W/Meter

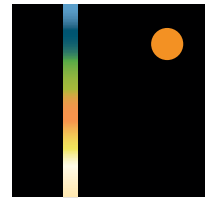





## LED Band 9,6W/m 48W/5m Rolle **Constantstrom** Single Color\*

LED Band 9,6W/m 24V DC 48W/Rolle		Warmweiß 2700K	IP20	Constantstrom	Preis 5m Rolle
	<b>Artikelnummer</b>	<b>35L482720CC</b>	Chip Typ	SMD S3528	Euro 86,20
	Spannung	24V DC	Lumen	720 lm per Meter	
	Lichtfarbe	2700k **	Breite/Länge	8mm/5000mm	
	Schutzart	IP20	Anzahl LED	120 LED per Meter	
	Trennbar	jedes 6 Chip 50mm	CRI80		

LED Band 9,6W/m 24V DC 48W/Rolle		Warmweiß 2700K	IP65	Constantstrom	Preis 5m Rolle
	<b>Artikelnummer</b>	<b>35L482765CC</b>	Chip Typ	SMD S3528	Euro 99,50
	Spannung	24V DC	Lumen	720 lm per Meter	
	Lichtfarbe	2700k **	Breite/Länge	8mm/5000mm	
	Schutzart	IP65	Anzahl LED	120 LED per Meter	
	Trennbar	jedes 6 Chip 50mm	CRI80		

LED Band 9,6W/m 24V DC 48W/Rolle		Neutralweiß 4000K	IP20	Constantstrom	Preis 5m Rolle
	<b>Artikelnummer</b>	<b>35L484020CC</b>	Chip Typ	SMD S3528	Euro 86,20
	Spannung	24V DC	Lumen	720 lm per Meter	
	Lichtfarbe	4000k **	Breite/Länge	8mm/5000mm	
	Schutzart	IP20	Anzahl LED	120 LED per Meter	
	Trennbar	jedes 6 Chip 50mm	CRI80		

LED Band 9,6W/m 24V DC 48W/Rolle		Neutralweiß 4000K	IP65	Constantstrom	Preis 5m Rolle
	<b>Artikelnummer</b>	<b>35L484065CC</b>	Chip Typ	SMD S3528	Euro 99,50
	Spannung	24V DC	Lumen	720 lm per Meter	
	Lichtfarbe	4000k **	Breite/Länge	8mm/5000mm	
	Schutzart	IP65	Anzahl LED	120 LED per Meter	
	Trennbar	jedes 6 Chip 50mm	CRI80		

**\* max 15 Meter bei einer Einspeisung**

\*\* Achtung ! Die exakte Lichtfarbe kann nur bei Bändern mit gleichem Produktionsdatum garantiert werden (ersichtlich auf der Originalverpackung).

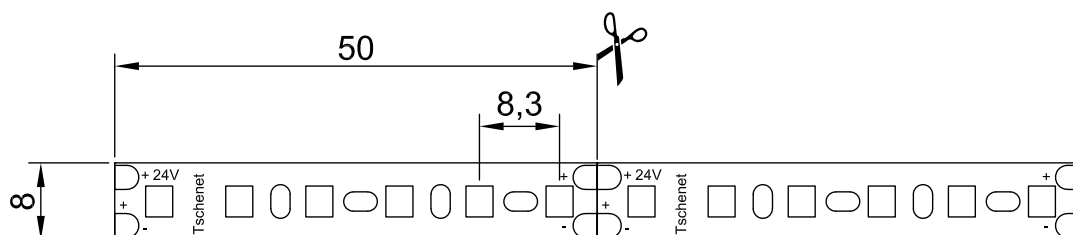

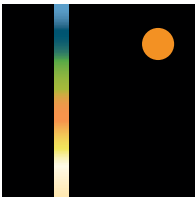

9,6W/Meter Constant Current



**LED Band 14,4W/m 72W/5m Rolle Single Color**

LED Band 14,4W/m 24V DC		72W/Rolle	Warmweiß 2700K	IP20	Preis 5m Rolle	
	<b>Artikelnummer</b>	<b>35L722720</b>	Chip Typ	SMD S5050	Euro 68,50	
	Spannung	24V DC	Lumen	1500 lm per Meter		
	Lichtfarbe	2700k **	Breite/Länge	10mm/5000mm		
	Schutzart	IP20	Anzahl LED	60 LED per Meter		
	Trennbar	jedes 6 Chip 100mm	CRI80			

LED Band 14,4W/m 24V DC		72W/Rolle	Warmweiß 2700K	IP65	Preis 5m Rolle	
	<b>Artikelnummer</b>	<b>35L722765</b>	Chip Typ	SMD S5050	Euro 89,90	
	Spannung	24V DC	Lumen	1500 lm per Meter		
	Lichtfarbe	2700k **	Breite/Länge	10mm/5000mm		
	Schutzart	IP65	Anzahl LED	60 LED per Meter		
	Trennbar	jedes 6 Chip 100mm	CRI80			

LED Band 14,4W/m 24V DC		72W/Rolle	Neutralweiß 4000K	IP20	Preis 5m Rolle	
	<b>Artikelnummer</b>	<b>35L724020</b>	Chip Typ	SMD S5050	Euro 68,50	
	Spannung	24V DC	Lumen	1500 lm per Meter		
	Lichtfarbe	4000k **	Breite/Länge	10mm/5000mm		
	Schutzart	IP20	Anzahl LED	60 LED per Meter		
	Trennbar	jedes 6 Chip 100mm	CRI80			

LED Band 14,4W/m 24V DC		72W/Rolle	Neutralweiß 4000K	IP65	Preis 5m Rolle	
	<b>Artikelnummer</b>	<b>35L724065</b>	Chip Typ	SMD S5050	Euro 89,90	
	Spannung	24V DC	Lumen	1500 lm per Meter		
	Lichtfarbe	4000k **	Breite/Länge	10mm/5000mm		
	Schutzart	IP65	Anzahl LED	60 LED per Meter		
	Trennbar	jedes 6 Chip 100mm	CRI80			

\*\* Achtung ! Die exakte Lichtfarbe kann nur bei Bändern mit gleichem Produktionsdatum garantiert werden (ersichtlich auf der Originalverpackung).

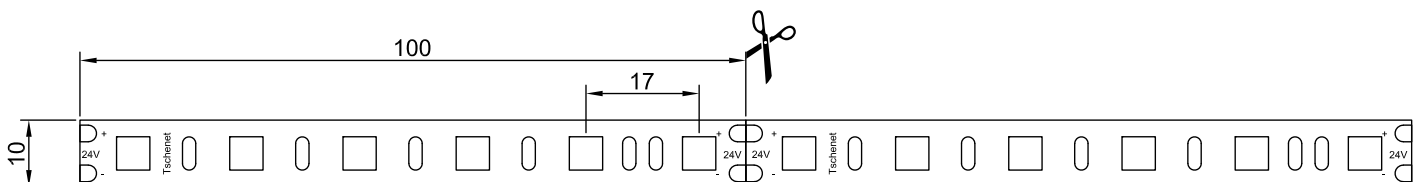

14,4W/Meter





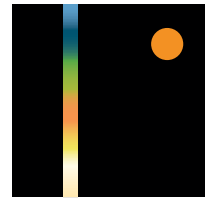



## LED Band 14,4W/m 72W/5m Rolle **Constantstrom** Single Color\*

LED Band 14,4W/m 24V DC 72W/Rolle Warmweiß 2700K IP20 <b>Constantstrom</b> Preis 5m Rolle																										
	<table border="1"> <tr> <td><b>Artikelnummer</b></td> <td><b>35L722720CC</b></td> <td>Chip Typ</td> <td>SMD S5050</td> <td>Euro 89,50</td> </tr> <tr> <td>Spannung</td> <td>24V DC</td> <td>Lumen</td> <td>1500 lm per Meter</td> <td></td> </tr> <tr> <td>Lichtfarbe</td> <td>2700k **</td> <td>Breite/Länge</td> <td>10mm/5000mm</td> <td></td> </tr> <tr> <td>Schutzart</td> <td>IP20</td> <td>Anzahl LED</td> <td>60 LED per Meter</td> <td></td> </tr> <tr> <td>Trennbar</td> <td>jedes 6 Chip 100mm</td> <td>CRI80</td> <td></td> <td></td> </tr> </table>	<b>Artikelnummer</b>	<b>35L722720CC</b>	Chip Typ	SMD S5050	Euro 89,50	Spannung	24V DC	Lumen	1500 lm per Meter		Lichtfarbe	2700k **	Breite/Länge	10mm/5000mm		Schutzart	IP20	Anzahl LED	60 LED per Meter		Trennbar	jedes 6 Chip 100mm	CRI80		
<b>Artikelnummer</b>	<b>35L722720CC</b>	Chip Typ	SMD S5050	Euro 89,50																						
Spannung	24V DC	Lumen	1500 lm per Meter																							
Lichtfarbe	2700k **	Breite/Länge	10mm/5000mm																							
Schutzart	IP20	Anzahl LED	60 LED per Meter																							
Trennbar	jedes 6 Chip 100mm	CRI80																								

LED Band 14,4W/m 24V DC 72W/Rolle Warmweiß 2700K IP65 <b>Constantstrom</b> Preis 5m Rolle																										
	<table border="1"> <tr> <td><b>Artikelnummer</b></td> <td><b>35L722765CC</b></td> <td>Chip Typ</td> <td>SMD S5050</td> <td>Euro 102,50</td> </tr> <tr> <td>Spannung</td> <td>24V DC</td> <td>Lumen</td> <td>1500 lm per Meter</td> <td></td> </tr> <tr> <td>Lichtfarbe</td> <td>2700k **</td> <td>Breite/Länge</td> <td>10mm/5000mm</td> <td></td> </tr> <tr> <td>Schutzart</td> <td>IP65</td> <td>Anzahl LED</td> <td>60 LED per Meter</td> <td></td> </tr> <tr> <td>Trennbar</td> <td>jedes 6 Chip 100mm</td> <td>CRI80</td> <td></td> <td></td> </tr> </table>	<b>Artikelnummer</b>	<b>35L722765CC</b>	Chip Typ	SMD S5050	Euro 102,50	Spannung	24V DC	Lumen	1500 lm per Meter		Lichtfarbe	2700k **	Breite/Länge	10mm/5000mm		Schutzart	IP65	Anzahl LED	60 LED per Meter		Trennbar	jedes 6 Chip 100mm	CRI80		
<b>Artikelnummer</b>	<b>35L722765CC</b>	Chip Typ	SMD S5050	Euro 102,50																						
Spannung	24V DC	Lumen	1500 lm per Meter																							
Lichtfarbe	2700k **	Breite/Länge	10mm/5000mm																							
Schutzart	IP65	Anzahl LED	60 LED per Meter																							
Trennbar	jedes 6 Chip 100mm	CRI80																								

LED Band 14,4W/m 24V DC 72W/Rolle Neutralweiß 4000K IP20 <b>Constantstrom</b> Preis 5m Rolle																										
	<table border="1"> <tr> <td><b>Artikelnummer</b></td> <td><b>35L724020CC</b></td> <td>Chip Typ</td> <td>SMD S5050</td> <td>Euro 89,50</td> </tr> <tr> <td>Spannung</td> <td>24V DC</td> <td>Lumen</td> <td>1500 lm per Meter</td> <td></td> </tr> <tr> <td>Lichtfarbe</td> <td>4000k **</td> <td>Breite/Länge</td> <td>10mm/5000mm</td> <td></td> </tr> <tr> <td>Schutzart</td> <td>IP20</td> <td>Anzahl LED</td> <td>60 LED per Meter</td> <td></td> </tr> <tr> <td>Trennbar</td> <td>jedes 6 Chip 100mm</td> <td>CRI80</td> <td></td> <td></td> </tr> </table>	<b>Artikelnummer</b>	<b>35L724020CC</b>	Chip Typ	SMD S5050	Euro 89,50	Spannung	24V DC	Lumen	1500 lm per Meter		Lichtfarbe	4000k **	Breite/Länge	10mm/5000mm		Schutzart	IP20	Anzahl LED	60 LED per Meter		Trennbar	jedes 6 Chip 100mm	CRI80		
<b>Artikelnummer</b>	<b>35L724020CC</b>	Chip Typ	SMD S5050	Euro 89,50																						
Spannung	24V DC	Lumen	1500 lm per Meter																							
Lichtfarbe	4000k **	Breite/Länge	10mm/5000mm																							
Schutzart	IP20	Anzahl LED	60 LED per Meter																							
Trennbar	jedes 6 Chip 100mm	CRI80																								

LED Band 14,4W/m 24V DC 72W/Rolle Neutralweiß 4000K IP65 <b>Constantstrom</b> Preis 5m Rolle																										
	<table border="1"> <tr> <td><b>Artikelnummer</b></td> <td><b>35L724065CC</b></td> <td>Chip Typ</td> <td>SMD S5050</td> <td>Euro 102,50</td> </tr> <tr> <td>Spannung</td> <td>24V DC</td> <td>Lumen</td> <td>1500 lm per Meter</td> <td></td> </tr> <tr> <td>Lichtfarbe</td> <td>4000k **</td> <td>Breite/Länge</td> <td>10mm/5000mm</td> <td></td> </tr> <tr> <td>Schutzart</td> <td>IP65</td> <td>Anzahl LED</td> <td>60 LED per Meter</td> <td></td> </tr> <tr> <td>Trennbar</td> <td>jedes 6 Chip 100mm</td> <td>CRI80</td> <td></td> <td></td> </tr> </table>	<b>Artikelnummer</b>	<b>35L724065CC</b>	Chip Typ	SMD S5050	Euro 102,50	Spannung	24V DC	Lumen	1500 lm per Meter		Lichtfarbe	4000k **	Breite/Länge	10mm/5000mm		Schutzart	IP65	Anzahl LED	60 LED per Meter		Trennbar	jedes 6 Chip 100mm	CRI80		
<b>Artikelnummer</b>	<b>35L724065CC</b>	Chip Typ	SMD S5050	Euro 102,50																						
Spannung	24V DC	Lumen	1500 lm per Meter																							
Lichtfarbe	4000k **	Breite/Länge	10mm/5000mm																							
Schutzart	IP65	Anzahl LED	60 LED per Meter																							
Trennbar	jedes 6 Chip 100mm	CRI80																								

**\* max 15 Meter bei einer Einspeisung**

\*\* Achtung ! Die exakte Lichtfarbe kann nur bei Bändern mit gleichem Produktionsdatum garantiert werden (ersichtlich auf der Originalverpackung).

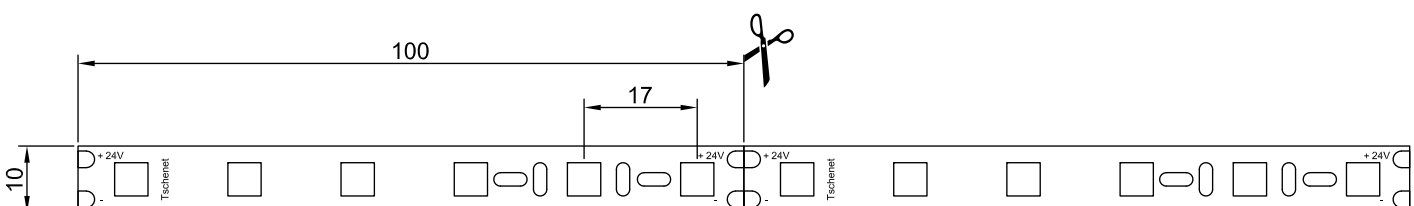

14,4W/Meter Constant Current

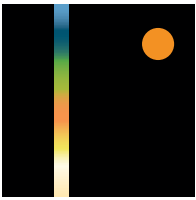

**LED Band 14,4W/m 72W/5m Rolle R G B**

LED Band 14,4W/m 24V DC 72W/Rolle R G B IP20				Preis 5m Rolle	
	<b>Artikelnummer</b>	<b>35L7220RGB</b>	Chip Typ	SMD S5050	Euro 76,60
	Spannung	24V DC	Lumen	1560 lm per Meter	
	Lichtfarbe	RGB **	Breite/Länge	10mm/5000mm	
	Schutzart	IP20	Anzahl LED	60 LED per Meter	
	Trennbar	jedes 6 Chip 100mm	CRI80		

LED Band 14,4W/m 24V DC 72W/Rolle R G B IP65				Preis 5m Rolle	
	<b>Artikelnummer</b>	<b>35L7265RGB</b>	Chip Typ	SMD S5050	Euro 89,90
	Spannung	24V DC	Lumen	1560 lm per Meter	
	Lichtfarbe	RGB **	Breite/Länge	10mm/5000mm	
	Schutzart	IP65	Anzahl LED	60 LED per Meter	
	Trennbar	jedes 6 Chip 100mm	CRI80		

\*\* Achtung ! Die exakte Lichtfarbe kann nur bei Bändern mit gleichem Produktionsdatum garantiert werden (ersichtlich auf der Originalverpackung).

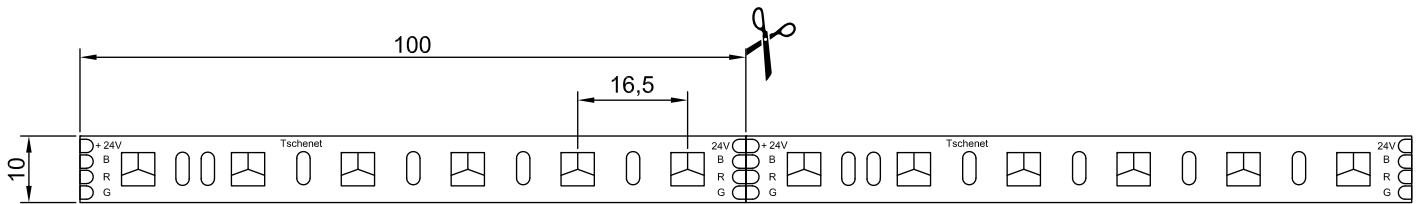



14,4W/Meter RGB

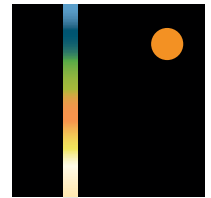





## LED Band 14,4W/m 72W/5m Rolle RGB + W

LED Band 14,4W/m 24V DC		72W/Rolle	R G B + W/Warmweiß 2700K	IP20	Preis 5m Rolle
	<b>Artikelnummer</b>	<b>35L722720RGBW</b>	Chip Typ	SMD S5050	Euro 97,70
	Spannung	24V DC	Lumen	1500 lm per Meter	
	Lichtfarbe	RGB+W 2700k **	Breite/Länge	12mm/5000mm	
	Schutzart	IP20	Anzahl LED	60 LED per Meter	
	Trennbar	jedes 10 Chip 166mm	CRI80		

LED Band 14,4W/m 24V DC		72W/Rolle	R G B + W/Warmweiß 2700K	IP65	Preis 5m Rolle
	<b>Artikelnummer</b>	<b>35L722765RGBW</b>	Chip Typ	SMD S5050	Euro 110,90
	Spannung	24V DC	Lumen	1500 lm per Meter	
	Lichtfarbe	RGB+W 2700k **	Breite/Länge	12mm/5000mm	
	Schutzart	IP65	Anzahl LED	60 LED per Meter	
	Trennbar	jedes 10 Chip 166mm	CRI80		

LED Band 14,4W/m 24V DC		72W/Rolle	R G B + W/Neutralweiß 4000K	IP20	Preis 5m Rolle
	<b>Artikelnummer</b>	<b>35L724020RGBW</b>	Chip Typ	SMD S5050	Euro 97,80
	Spannung	24V DC	Lumen	1500 lm per Meter	
	Lichtfarbe	RGB+W 4000k **	Breite/Länge	12mm/5000mm	
	Schutzart	IP20	Anzahl LED	60 LED per Meter	
	Trennbar	jedes 10 Chip 166mm	CRI80		

LED Band 14,4W/m 24V DC		72W/Rolle	R G B + W/Neutralweiß 4000K	IP65	Preis 5m Rolle
	<b>Artikelnummer</b>	<b>35L724065RGBW</b>	Chip Typ	SMD S5050	Euro 110,90
	Spannung	24V DC	Lumen	1500 lm per Meter	
	Lichtfarbe	RGB+W 4000k **	Breite/Länge	12mm/5000mm	
	Schutzart	IP65	Anzahl LED	60 LED per Meter	
	Trennbar	jedes 10 Chip 166mm	CRI80		

\*\* Achtung ! Die exakte Lichtfarbe kann nur bei Bändern mit gleichem Produktionsdatum garantiert werden (ersichtlich auf der Originalverpackung).

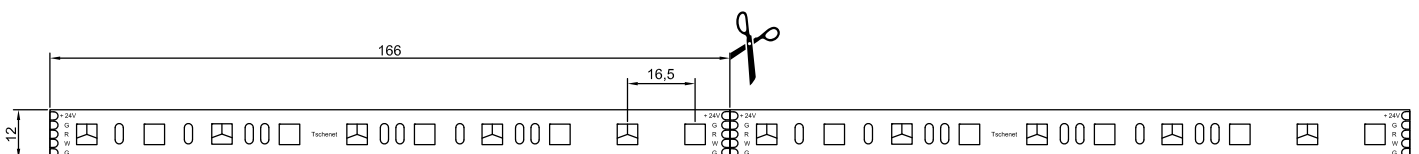

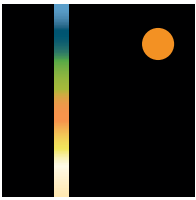

14,4W/Meter RGBW



**LED Band 19,2W/m 96W/5m Rolle Single Color**

LED Band 19,2W/m 24V DC 96W/Rolle Warmweiß 2700K IP20		Preis 5m Rolle			
	<b>Artikelnummer</b>	<b>35L962720</b>	Chip Typ	SMD S3528	Euro 110,90
	Spannung	24V DC	Lumen	1680 lm per Meter	
	Lichtfarbe	2700k **	Breite/Länge	10mm/5000mm	
	Schutzart	IP20	Anzahl LED	240 LED per Meter	
	Trennbar	jedes 6 Chip 50mm	CRI80		

LED Band 19,2W/m 24V DC 96W/Rolle Warmweiß 2700K IP65		Preis 5m Rolle			
	<b>Artikelnummer</b>	<b>35L962765</b>	Chip Typ	SMD S3528	Euro 122,70
	Spannung	24V DC	Lumen	1680 lm per Meter	
	Lichtfarbe	2700k **	Breite/Länge	10mm/5000mm	
	Schutzart	IP65	Anzahl LED	240 LED per Meter	
	Trennbar	jedes 6 Chip 25mm	CRI80		

LED Band 19,2W/m 24V DC 96W/Rolle Neutralweiß 4000K IP20		Preis 5m Rolle			
	<b>Artikelnummer</b>	<b>35L964020</b>	Chip Typ	SMD S3528	Euro 110,90
	Spannung	24V DC	Lumen	1680 lm per Meter	
	Lichtfarbe	4000k **	Breite/Länge	10mm/5000mm	
	Schutzart	IP20	Anzahl LED	240 LED per Meter	
	Trennbar	jedes 6 Chip 25mm	CRI80		

LED Band 19,2W/m 24V DC 96W/Rolle Neutralweiß 4000K IP65		Preis 5m Rolle			
	<b>Artikelnummer</b>	<b>35L964065</b>	Chip Typ	SMD S3528	Euro 122,70
	Spannung	24V DC	Lumen	1680 lm per Meter	
	Lichtfarbe	4000k **	Breite/Länge	10mm/5000mm	
	Schutzart	IP65	Anzahl LED	240 LED per Meter	
	Trennbar	jedes 6 Chip 25mm	CRI80		

\*\* Achtung ! Die exakte Lichtfarbe kann nur bei Bändern mit gleichem Produktionsdatum garantiert werden (ersichtlich auf der Originalverpackung).

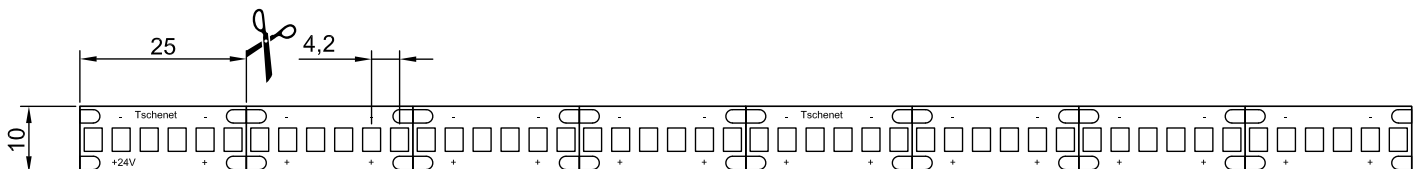

19,2W/Meter



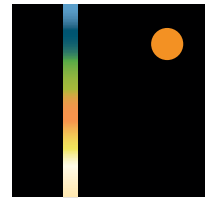

## LED Bänder Zubehör

LED Bänder Zubehör		Connectoren für 8mm Bänder			2-polig	Preis/Stk.
	Artikelnummer	<b>36EGAQCWSS2D08IP20</b>	IP20	Connector 2 polig, 8mm, 12-24V, 0-3A, 30-120leds/m, Weiss	Euro 0,32	
	Artikelnummer	<b>36EGAQCWSS208IP65</b>	IP65	Connector 2 polig, 8mm, 12-24V, 0-4A, 30-120leds/m, Weiss	Euro 0,42	
	Artikelnummer	<b>36EGAQCWCS2D08IP20</b>	IP20	Connector 2 polig, 8mm, 12-24V, Kabel 150mm, 0-3A, 30-120leds/m, Weiss	Euro 0,42	
	Artikelnummer	<b>36EGAQCWCS208IP65</b>	IP65	Connector 2 polig, 8mm, 12-24V, Kabel 150mm, 0-4A, 30-120leds/m, Weiss	Euro 0,58	
	Artikelnummer	<b>36EGAQCWSCS2D08IP20</b>	IP20	Doppel Connector 2 polig, 8mm, 12-24V, Kabel 150mm, 0-3A, 30-120leds/m, Weiss	Euro 0,74	
	Artikelnummer	<b>36EGAQCWSCS208IP65</b>	IP65	Doppel Connector 2 polig, 8mm, 12-24V, Kabel 150mm, 0-4A, 30-120leds/m, Weiss	Euro 1,11	
	Artikelnummer	<b>36EGAQCMCS208IP20</b>	IP20	Connector 2 polig, 8mm, 12-24V, 0-5A, mit Kabelsteckklemme, 30-120leds/m, Weiss	Euro 1,21	

LED Bänder Zubehör		Connectoren für 10mm Bänder			2-polig	Preis/Stk.
	Artikelnummer	<b>36EGAQCWSS2D10IP20</b>	IP20	Connector 2 polig, 10mm, 12-24V, 0-3A, 30-120leds/m, Weiss	Euro 0,32	
	Artikelnummer	<b>36EGAQCWCS210IP65</b>	IP65	Connector 2 polig, 10mm, 12-24V, Kabel 150mm, 0-4A, 30-120leds/m, Weiss	Euro 0,63	
	Artikelnummer	<b>36EGAQCWCS2D10IP20</b>	IP20	Connector 2 polig, 10mm, 12-24V, Kabel 150mm, 0-3A, 30-120leds/m, Weiss	Euro 0,48	
	Artikelnummer	<b>36EGAQCWCS210IP65</b>	IP65	Connector 2 polig, 10mm, 12-24V, Kabel 150mm, 0-4A, 30-120leds/m, Weiss	Euro 0,63	
	Artikelnummer	<b>36EGAQCWSCS2D10IP20</b>	IP20	Doppel Connector 2 polig, 10mm, 12-24V, Kabel 150mm, 0-3A, 30-120leds/m, Weiss	Euro 0,79	
	Artikelnummer	<b>36EGAQCWSCS210IP65</b>	IP65	Doppel Connector 2 polig, 10mm, 12-24V, Kabel 150mm, 0-4A, 30-120leds/m, Weiss	Euro 1,21	
	Artikelnummer	<b>36EGAQCMCS210IP20</b>	IP20	Connector 2 polig, 10mm, 12-24V, 0-5A, mit Kabelsteckklemme, 30-120leds/m, Weiss	Euro 1,27	
	Artikelnummer	<b>41S010-10mm-2pin</b>	IP20	L-Connector 2-pin 10mm	Euro 0,58	
	Artikelnummer	<b>41S011-10mm-2pin</b>	IP20	T-Connector 2-pin 10mm	Euro 0,63	



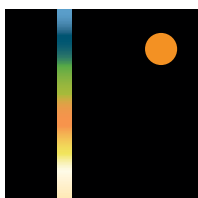

## LED Bänder Zubehör

	Artikelnummer	<b>41S012-10mm-2pin</b>	IP20	X-Connector 2-pin 10mm	Euro 0,74

### LED Bänder Zubehör **Connectoren für 10mm Bänder** **4-polig** **R G B** Preis/Stk.

	Artikelnummer	<b>36EGAQCMSS410IP20</b>	IP20	Connector 4 polig, 10mm, 12-24V, 0-5A, 30-120leds/m, Weiss	Euro 0,85
	Artikelnummer	<b>36EGAQCWSS410IP65</b>	IP65	Connector 4 polig, 10mm, 12-24V, 0-4A, 30-120leds/m, Weiss	Euro 1,06

	Artikelnummer	<b>36EGAQCWCS410IP20</b>	IP20	Connector 4 polig, 10mm, 12-24V, Kabel 150mm, 0-3A, 30-60leds/m, Weiss	Euro 0,58
	Artikelnummer	<b>36EGAQCWCS410IP65</b>	IP65	Connector 4 polig, 10mm, 12-24V, Kabel 150mm, 0-4A, 30-120leds/m, Weiss	Euro 0,74

	Artikelnummer	<b>36EGAQCWSCS410IP20</b>	IP20	Doppel Connector 4 polig, 10mm, 12-24V, Kabel 150mm, 0-3A, 30-60leds/m, Weiss	Euro 1,06
	Artikelnummer	<b>36EGAQCWCS410IP65</b>	IP65	Connector 4 polig, 10mm, 12-24V, Kabel 150mm, 0-4A, 30-120leds/m, Weiss	Euro 1,77

### LED Bänder Zubehör **Connectoren für 12mm Bänder** **5-polig** **R G B + W** Preis/Stk.

	Artikelnummer	<b>36EGAQCWSS512IP20</b>	IP20	Connector 5 polig, 12mm, 12-24V, 0-3A, 30-60leds/m, Weiss	€ 0,53

	Artikelnummer	<b>36EGAQCWCS512IP20</b>	IP20	Connector 5 polig, 12mm, 12-24V, Kabel 150mm, 0-3A, 30-60leds/m, Weiss	€ 0,84

	Artikelnummer	<b>36EGAQCWSCS512IP20</b>	IP20	Doppel Connector 5 polig, 12mm, 12-24V, Kabel 150mm, 0-3A, 30-60leds/m, Weiss	€ 1,27



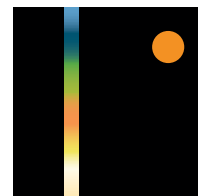

## LED Bänder Zubehör

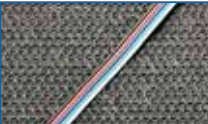
LED Bänder Zubehör <b>S o n s t i g e s</b>					Preis/Stk.
	Artikelnummer	<b>35STRIPCABLE2</b>		Strip Kabel 2-polig per Meter	Euro 1,10
	Artikelnummer	<b>35RGBSTRIPCABLE4</b>		Strip Kabel RGB 4-polig per Meter	Euro 1,40
	Artikelnummer	<b>35RGBWSTRIPCABLE5</b>		Strip Kabel RGBW 5-polig per Meter	Euro 2,20
	Artikelnummer	<b>41SSW-025-005</b>	IP20	Male Connector max. 6A,24V mit Kabel 300mm Transparent	Euro 1,21
	Artikelnummer	<b>41SSW-025-006</b>	IP20	Female Connector max. 6A,24V mit Kabel 300mm Transparent	Euro 1,21
	Artikelnummer	<b>41SDCwireplugfemale</b>	IP20	Kupplung Female DC plug	Euro 1,74
	Artikelnummer	<b>41SDCwireplugmale</b>	IP20	Stecker Male DC plug	Euro 1,74
	Artikelnummer	<b>41SSW-WC-2-F</b>	IP65	15cm 22AWG Kabel mit Kupplung 2-pol Kabel 300mm Transparent	Euro 3,48
	Artikelnummer	<b>41SSW-WC-2-M</b>	IP65	15cm 22AWG Kabel mit Stecker 2-pol Kabel 300mm Transparent	Euro 3,00







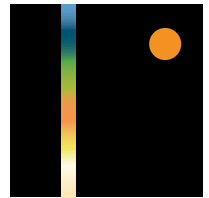

## Steuerungen und Fernbedienungen

Single Color Dimmer S E T 1-Kanal				Preis/Stk.	
Fernbedienung und Controller, für Single Color Bänder, 1 Kanal	<b>Artikelnummer</b>	35LLM-DC5	IP20	Single Color Dimmer Touch Screen	Euro 42,77
				<b>1-Kanal</b> je 6A 12-24VDC	

Mit dieser Fernbedienung ist es möglich, ein LED-Band mit der Fernbedienung zu bedienen. Im blauen „Kreis“ können Sie die Helligkeit einstellen.



Single Color Dimmer Unterputzmontage 1-Kanal				Preis/Stk.	
Unterputzdimmer für Single Color Bänder 1 Kanal	<b>Artikelnummer</b>	<b>35LLM-TOUCH-MB01</b>	IP20	1 Kanal LED Strip Dimmer	Euro 34,50
				Touch Screen 6A 12-24VDC	
				für Unterputzmontage, <b>passt nicht in eine herkömmliche Schalterdose!</b>	

Mit dieser Fernbedienung ist es möglich, die Helligkeit von Single Color LED-Bändern mittels Touch Screen einzustellen.



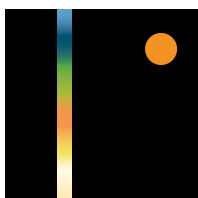

## Steuerungen und Fernbedienungen

Single Color Dimmer	4-Kanal				Preis/Stk.
Fernbedienung und Controller für Single Color Bänder, 4 Kanal	<b>Artikelnummer</b>	<b>35LLM-DC8</b>	IP20	Single Color Dimmer Touch Screen	Euro 52,30
				<b>4-Kanal</b> je 6A 12-24VDC	
	<b>Artikelnummer</b>	<b>35LLM-DC8R</b>	IP20	Single Color Controller (max. 4)	Euro 30,70
				<b>für DC8</b>	

Mit dieser Fernbedienung ist es möglich, mehrere Gruppen von LED-Bändern zu steuern. Sie können somit 4 Kreise separat oder in Gruppen mit einer Fernbedienung bedienen. Im schwarzen „Kreis“ können Sie oben /unten die Helligkeit einstellen sowie links/rechts die Farbtemperatur.



RGB / RGBW Color Dimmer	SET	1-Kanal			Preis/Stk.
Fernbedienung und Controller, für RGB und RGBW LED-Bänder, 1 Kanal	<b>Artikelnummer</b>	<b>35LLM-ACT18</b>	IP20	RGB/RGBW LED Strip Dimmer	€ 39,90
				Touch Screen 1-Kanal je 6A	

Mit dieser Fernbedienung ist es möglich, ein LED-Band zu steuern. Im farbigen „Kreis“ können Sie die Farben einstellen.



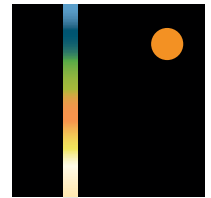

## Steuerungen und Fernbedienungen

R G B / R G B W Color Dimmer 4-Kanal					Preis/Stk.
Fernbedienung und Controller für RGB/RGBW Bänder, 4 Kanal	<b>Artikelnummer</b>	<b>35LLM-FU095</b>	IP20	RGB/RGBW Dimmer Touch Screen	Euro 39,90
				<b>4-Kanal</b> je 6A 12-24VDC	
	<b>Artikelnummer</b>	<b>35LLM-FU038</b>	IP20	RGB/RGBW Controller (max. 4)	Euro 30,70
				<b>für FU095</b>	

Mit dieser Fernbedienung ist es möglich, mehrere Gruppen von RGB/RGBW-Bändern zu steuern. Sie können somit 4 Kreise separat oder in Gruppen mit einer Fernbedienung bedienen. Im bunten „Kreis“ können Sie die Helligkeit einstellen.



FU038



FU095

R G B / R G B W Color Dimmer Unterputzmontage 4-Kanal					Preis/Stk.
Unterputzdimmer für RGB und RGBW Bänder, 4 Kanal	<b>Artikelnummer</b>	<b>35LLM-TOUCH-MB04</b>	IP20	4 Kanal LED Strip RGB-RGBW Controller	Euro 34,50
				Touch Screen 6A 12-24VDC	
				für Unterputzmontage, <b>passt nicht in eine herkömmliche Schalterdose!</b>	

Mit dieser Fernbedienung ist es möglich, RGB und RGBW LED-Bändern zu steuern. Im farbigen „Kreis“ können Sie die Farben einstellen.



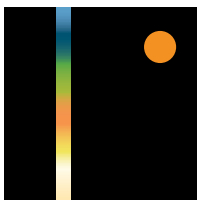

## Trafo´s nicht dimmbar

	<b>Artikelnummer</b>	<b>34MGPV-20-24</b>		<b>20 Watt 24V</b>	Euro 13,20
	<b>Spannung Sec.</b>	24VDC	<b>LBH</b>	<b>140x32x25mm</b>	
	<b>Spannung Prim.</b>	100-240VAC	<b>1A</b>	output Current	
	<b>Leistung</b>	24W		nicht dimmbar	
	<b>Schutzart</b>	IP67			
	<b>Artikelnummer</b>	<b>34MGPV-35-24</b>		<b>35 Watt 24V</b>	Euro 21,20
	<b>Spannung Sec.</b>	24VDC	<b>LBH</b>	<b>148x32x28mm</b>	
	<b>Spannung Prim.</b>	100-240VAC	<b>1,5A</b>	output Current	
	<b>Leistung</b>	36W		nicht dimmbar	
	<b>Schutzart</b>	IP67			
	<b>Artikelnummer</b>	<b>34MGPV-60-24</b>		<b>60 Watt 24V</b>	Euro 28,10
	<b>Spannung Sec.</b>	24VDC	<b>LBH</b>	<b>162x42x33mm</b>	
	<b>Spannung Prim.</b>	100-240VAC	<b>2,5A</b>	output Current	
	<b>Leistung</b>	60W		nicht dimmbar	
	<b>Schutzart</b>	IP67			
	<b>Artikelnummer</b>	<b>34MGPV-75-24</b>		<b>75W 24V</b>	Euro 32,40
	<b>Spannung Sec.</b>	24VDC	<b>LBH</b>	<b>162x42x33mm</b>	
	<b>Spannung Prim.</b>	100-240VAC	<b>3A</b>	output Current	
	<b>Leistung</b>	72W		nicht dimmbar	
	<b>Schutzart</b>	IP67			
	<b>Artikelnummer</b>	<b>34MGPV-100-24</b>		<b>100W 24V</b>	Euro 43,00
	<b>Spannung Sec.</b>	24VDC	<b>LBH</b>	<b>187x42x33mm</b>	
	<b>Spannung Prim.</b>	100-240VAC	<b>4,2A</b>	output Current	
	<b>Leistung</b>	100,8W		nicht dimmbar	
	<b>Schutzart</b>	IP67			
	<b>Artikelnummer</b>	<b>34MGPV-150-24</b>		<b>150W 24V</b>	Euro 61,00
	<b>Spannung Sec.</b>	24VDC	<b>LBH</b>	<b>203x70x45mm</b>	
	<b>Spannung Prim.</b>	100-240VAC	<b>6A</b>	output Current	
	<b>Leistung</b>	144W		nicht dimmbar	
	<b>Schutzart</b>	IP67			
	<b>Artikelnummer</b>	<b>34MGLG-200-24</b>		<b>200W 24V</b>	Euro 115,50
	<b>Spannung Sec.</b>	24VDC	<b>LBH</b>	<b>242x96x50mm</b>	
	<b>Spannung Prim.</b>	100-240VAC	<b>8,25A</b>	output Current	
	<b>Leistung</b>	192W		nicht dimmbar	
	<b>Schutzart</b>	IP67			
	<b>Artikelnummer</b>	<b>34MMCHQ250V24-E</b>		<b>250W 24V</b>	Euro 102,15
	<b>Spannung Sec.</b>	24VDC	<b>LBH</b>	<b>225,8x61,5x36,5</b>	
	<b>Spannung Prim.</b>	200-240VAC	<b>10,4A</b>	output Current	
	<b>Leistung</b>	250W		nicht dimmbar	
	<b>Schutzart</b>	IP67			
	<b>Artikelnummer</b>	<b>34MGLG-300-24</b>		<b>300W 24V</b>	Euro 151,00
	<b>Spannung Sec.</b>	24VDC	<b>LBH</b>	<b>285x96x50mm</b>	
	<b>Spannung Prim.</b>	100-240VAC	<b>12,5A</b>	output Current	
	<b>Leistung</b>	300W		nicht dimmbar	
	<b>Schutzart</b>	IP67			



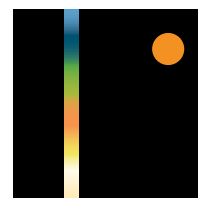

## Trafo´s dimmbar

	Artikelnummer	<b>34MMCHQ100V24B</b>		<b>100W 24V</b>	Euro 78,90
	Spannung Sec.	24VDC	<b>LBH</b>	<b>190x61,5x36,5mm</b>	
	Spannung Prim.	100-240VAC	<b>6,3A</b>	output Current	
	Leistung	99W		1-10V dimmbar	
	Schutzart	IP67			
	Artikelnummer	<b>34MMCHQ150V24B</b>		<b>150W 24V</b>	Euro 91,50
	Spannung Sec.	24VDC	<b>LBH</b>	<b>221x61,5x36,5mm</b>	
	Spannung Prim.	100-240VAC	<b>6,3A</b>	output Current	
	Leistung	151,2W		1-10V dimmbar	
	Schutzart	IP67			
	Artikelnummer	<b>34MMCHQ250V24E</b>		<b>250W 24V</b>	Euro 103,00
	Spannung Sec.	24VDC	<b>LBH</b>	<b>221x61,5x36,5mm</b>	
	Spannung Prim.	100-240VAC	<b>10,4A</b>	output Current	
	Leistung	151,2W		1-10V dimmbar	
	Schutzart	IP67			
	Artikelnummer	<b>2128001663</b>		<b>60W 24V/one4all</b>	Euro 132,54
	Spannung Sec.	24VDC	<b>LBH</b>	<b>225x43x30mm</b>	
	Spannung Prim.	100-240VAC		output Current	
	Leistung	60W		one4all (Dali/DSI/SWITCH/corridor)	
	Schutzart	IP20		3 polige Dimmung	
	Artikelnummer	<b>2187500665</b>		<b>60W 24V/PWM-dim</b>	Euro 46,50
	Spannung Sec.	24VDC	<b>LBH</b>	<b>225x43x30,2mm</b>	
	Spannung Prim.	100-240VAC		output Current	
	Leistung	60W		dimmbar mit PWM LED Dimmer	
	Schutzart	IP20			
	Artikelnummer	<b>2128001253</b>		<b>100W 24V/one4all</b>	Euro 147,06
	Spannung Sec.	24VDC	<b>LBH</b>	<b>295x43x29,8mm</b>	
	Spannung Prim.	100-240VAC		output Current	
	Leistung	100W		one4all (Dali/DSI/SWITCH/corridor)	
	Schutzart	IP20		3 polige Dimmung	
	Artikelnummer	<b>2187500666</b>		<b>100W 24V/PWM dim</b>	Euro 61,14
	Spannung Sec.	24VDC	<b>LBH</b>	<b>295x43x30mm</b>	
	Spannung Prim.	100-240VAC		output Current	
	Leistung	100W		dimmbar mit PWM LED Dimmer	
	Schutzart	IP20			

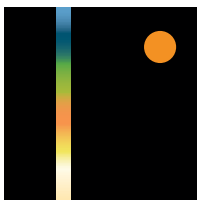

## LED Bänder und Profile Konfektionierungen

LED Bänder Konfektionierungen				Preis/Stk.
Konfektionieren LED Band auf die gewünschte Länge	<b>Artikelnummer</b>	KonfektionierungB	Grundpreis incl. Einspeisung bis 1 Meter	Euro 8,00
		KonfektionierungB1	je weiterer Meter Einspeisung 2-polig	Euro 1,10
		KonfektionierungB2	je weiterer Meter Einspeisung 4-polig	Euro 1,40
		KonfektionierungB3	je weiterer Meter Einspeisung 5-polig	Euro 2,20
		KonfektionierungB4	Neuversiegelung bei IP65	Euro 1,80
		KonfektionierungB5	Auflöten Stecker oder Kupplung für Trafo	Euro 8,00



LED Profile Konfektionierungen				Preis/Stk.
Konfektionieren LED Profil auf die gewünschte Länge	<b>Artikelnummer</b>	KonfektionierungP	Schneiden Profil	Euro 8,00
		KonfektionierungP1	Schneiden Abdeckung	Euro 4,00



Für weitere Konfektionierungen senden Sie uns bitte eine Anfrage





Alle Preise exkl. MwSt., technische Änderungen und Irrtümer sowie Druckfehler vorbehalten.

**Gültig ab 01.01.2020 bis auf Widerruf.**

**Es gelten die Geschäftsbedingungen der Tschenet Licht GmbH, welche unter [www.tschenet.at](http://www.tschenet.at) einsehbar sind.**

**Tschenet Licht GmbH  
Eduard-Bodem-Gasse 8  
6020 Innsbruck  
office@tschenet.at  
www.tschenet.at  
tel. +43 (0)512 34 34 05  
ATU62613577**

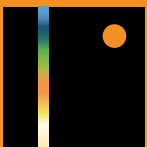

**Tschenet**  
Licht GmbH

Tschenet Licht GmbH  
Eduard-Bodem-Gasse 8  
6020 Innsbruck  
Österreich  
+43 512 343405  
office@tschenet.at  
tschenet.at